

# Contents

<b>Chapter 1</b>	<b>iCopy</b> . . . . .	<b>1</b>
	Introduction . . . . .	1
	Open Target Assembly . . . . .	2
	iCopy . . . . .	3
	Constrain iCopy . . . . .	4
	Constrain iCopy - Pattern . . . . .	6
	Copy / Reuse iCopy Components . . . . .	8
	Open the Template Layout Part . . . . .	8
	Create the iCopy Template Assembly . . . . .	9
	Constrain the Template Layout Part . . . . .	10
	iCopy Author - Layout tab . . . . .	11
	iCopy Author - Geometry tab . . . . .	11
	iCopy Author - Parameter tab . . . . .	14
	Test the iCopy Definition . . . . .	14
	Create a Frame Part . . . . .	19
	Complete the Assembly . . . . .	21
	Constrain the Frame Part . . . . .	22
	Test the iCopy Definition . . . . .	23
	Place the Support Plates . . . . .	28
	Test the iCopy Definition . . . . .	29
	Summary . . . . .	34
	<b>Index</b> . . . . .	<b>35</b>



# iCopy

# 1

## Introduction

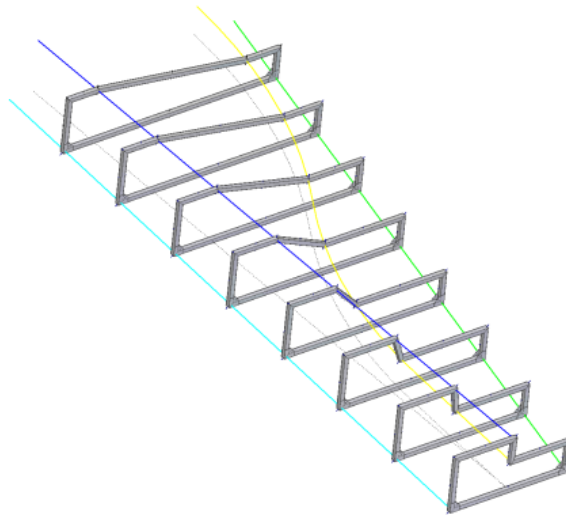

Place iCopy results in a target assembly. Complete a skeleton assembly and author the assembly to use with iCopy.

<b>Skill Level</b>	<b>Level 3</b> Specific Interest
<b>Time Required</b>	30 minutes
<b>Tutorial Files Used</b>	Frame.iam, Top.iam

### Learn how to

- Place iCopy results
- Complete a skeleton assembly
- Prepare an assembly for the iCopy Author
- Author an iCopy template

### Prerequisites

- Know how to navigate the model space with the various view tools, and perform common modeling functions, such as sketching and selecting geometry.
- Have a basic understanding of adaptivity and how it affects parts and assemblies.
- Understand the basics of skeleton modeling.

The iCopy command automates the process of copying and positioning similar components in the main assembly. iCopy combines skeletal modeling and adaptivity to allow the subassembly to change shape to fit its position in the model. The iCopy Author command creates an iCopy template from an adaptive skeleton assembly. The iCopy command creates one or multiple copies of the iCopy template and adds each copy to the target assembly. Each assembly (iCopy result) can vary slightly from other iCopy results in the pattern depending on the adaptivity that was used in the iCopy template.

### Navigation Tips

- Use the **Show** button in the upper-left corner to display the table of contents for this tutorial with navigation links to each page.
- Use the **Forward** button in the upper-right corner to advance to the next page.

## Open Target Assembly

The target assembly contains the geometry necessary to position the iCopy results. To place a single iCopy result, you need a work point for each point defined in the iCopy template. To place multiple iCopy results, you need a work point for each point in the iCopy definition, a rail to define the path

for each work point, a work plane to define the position of the iCopy results, and a path for the pattern.

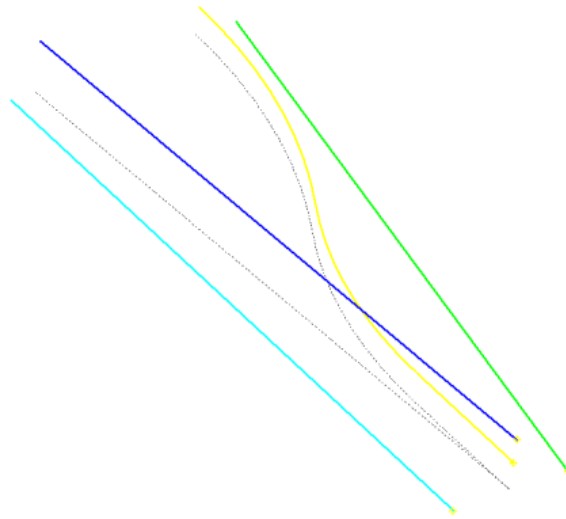

- 1 Open Target.iam.



- 2 The assembly contains a single part. The part contains sketch geometry and work points. You use the work points to position iCopy results.

## iCopy

Use the iCopy command to position iCopy results. First, select the iCopy template to use. Then select geometry to position, size and pattern the iCopy results, and control the copy or reuse of components.

- 1 Start the **iCopy** command. 
  - In the Ribbon: Assemble tab ► Component panel ► **iCopy**
  - In the classic interface: Assembly panel ► iCopy
- 2 Click  and select **Frame-start.iam**. Click **Open**. This assembly has been authored using the iCopy Author command. The Constrain iCopy dialog box displays.

## Constrain iCopy

In the Constrain iCopy dialog box, position the iCopy result in the target assembly. Select work points to position the geometry. You can modify values for any parameters included in the iCopy definition.

- 1 Select the work point at the end of the cyan (light blue) line for the Lower left point.

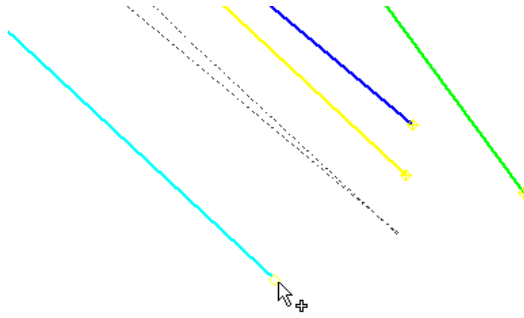

- 2 Select the work point at the end of the green line for the Lower right point.

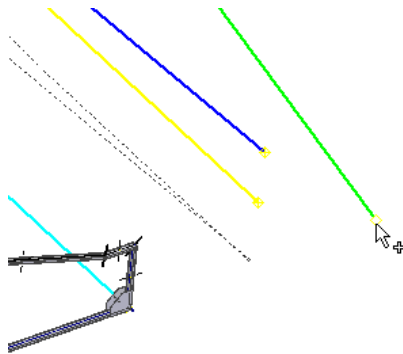

- 3 Select the work point at the end of the blue line for the Upper left point.

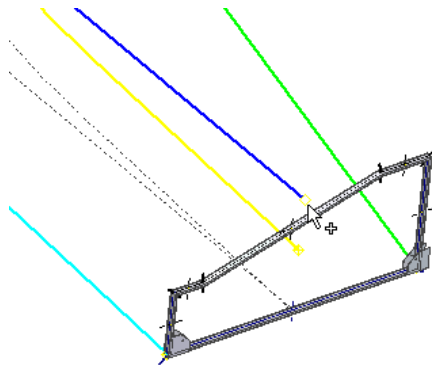

- 4 Select the work point at the end of the yellow spline for the Upper right point.

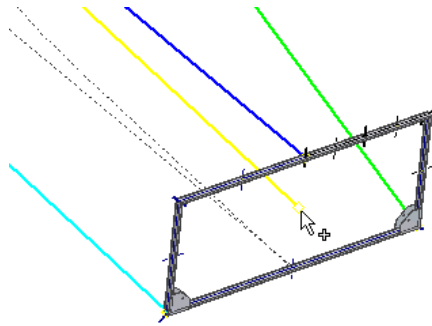

- 5 In the Frame Height field, enter **5 in.**
- 6 In the Frame Width field, enter **5 in.**

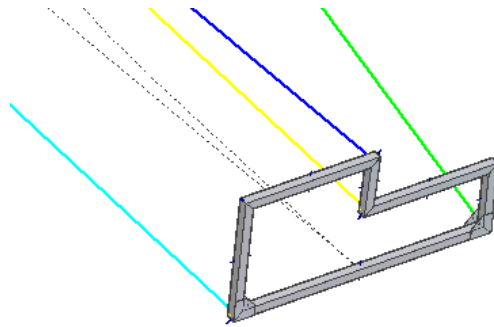

- 7 In the lower right of the dialog box, click  in the lower right of the dialog box to display the multiple results settings.

## Constrain iCopy - Pattern

In the Constrain iCopy dialog box, in the multiple mode, pattern the iCopy results in the target assembly. Rails are automatically selected based on the work points used to position the iCopy. The rails control the positioning of work points for additional iCopy results. You select a path to determine the direction of the iCopy results pattern. A work plane is used to determine the position of the iCopy results. This work plane is selected automatically.

- 1 Select the cyan (light blue) line to use as the path for the pattern (the Path button is selected automatically).

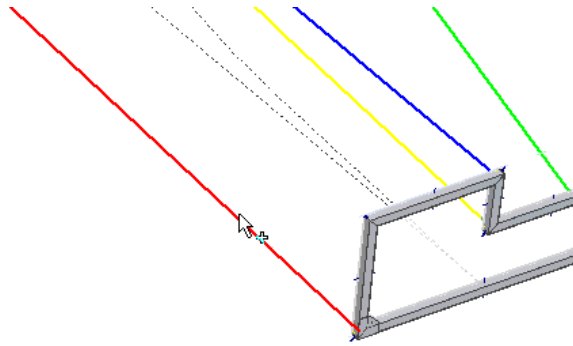

The Work Plane is selected automatically, based on the selected path.

- 2 In the Instance number field, enter **8 in.**
- 3 In the Offset field, enter **100.**

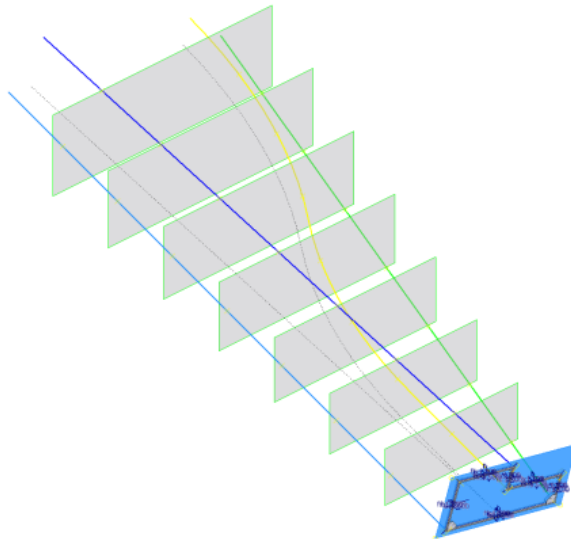

- 4 Click **Next.**

## Copy / Reuse iCopy Components

In the Copy / Reuse iCopy Components dialog box, copy or reuse components in the iCopy definition. Components that are reused are referenced by all iCopy results. Reuse components that do not change between iCopy results. Copy components that change between iCopy results.

- 1 Click **OK**. The plates reference the same part file for each iCopy result (reuse). All other components are copied for each iCopy result (copy).

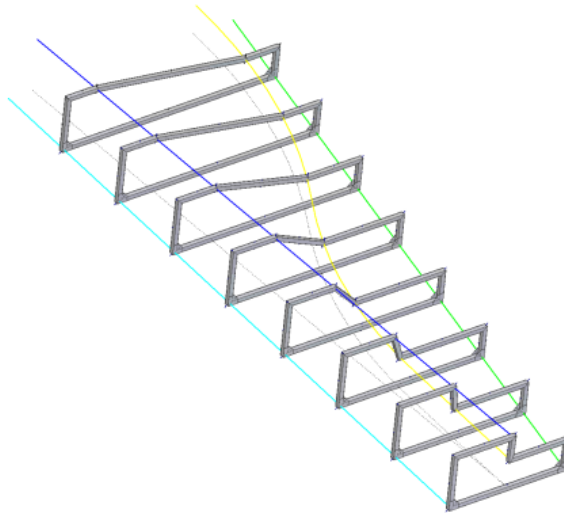

- 2 Close the file. Do not save changes. The Target.iam assembly is used later in the exercise.

## Open the Template Layout Part

Now you examine the files that compose the iCopy template, then author an iCopy template. The template layout part is the base part for the skeleton assembly that is the iCopy template. The template layout part contains the geometry that is derived into the skeleton components.

- 1 Open Skeleton-frame.ipt.

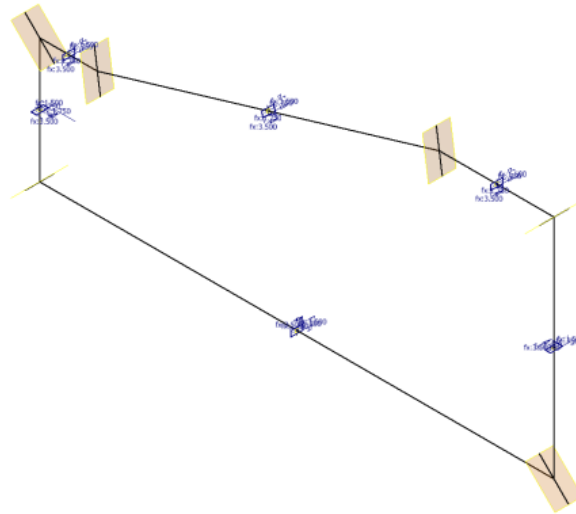

- 2 This file contains several sketches, work geometry, and surface features.
  - Sketch1 contains the layout geometry for the skeleton model.
  - Sketch2 through Sketch7 contain the profiles used to create the frame members.
  - The work planes are used to position the sketches.
  - Sketch8 is used to create ExtrusionSrf13 through ExtrusionSrf18.
  - ExtrusionSrf13 through ExtrusionSrf18 are used to terminate the extrusions for the frames.
- 3 Right-click Sketch1 and select **Adaptive**.
- 4 Save and close the file.

## Create the iCopy Template Assembly

The iCopy template assembly contains the skeleton geometry that is used to create an iCopy definition. You create an assembly, place the Skeleton-frame.ipt component, and then constrain it.

- 1 Create an assembly based on the Standard (in).iam template.

- 2 Use the Place Component command to place one instance of Skeleton-frame.ipt.

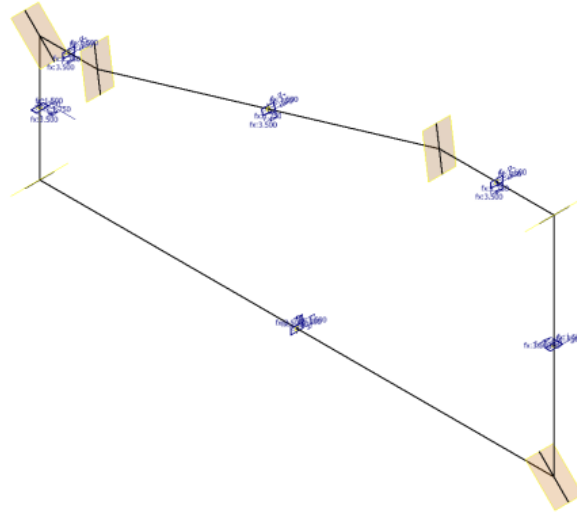

- 3 Right-click Skeleton-frame:1 and select **Adaptive**.
- 4 Save the assembly as Frame.iam.

## Constrain the Template Layout Part

For the iCopy results to update properly, the origin of the template layout part must be constrained to the origin of the assembly. The template layout part can remain grounded.

- 1 In the browser, expand the Origin folders for Skeleton-frame:1 and Frame.iam.
- 2 Start the Constrain command. In the Solution area of the dialog box,
  - select the Flush option.
  - In the Origin folder of Skeleton-frame:1, select the XY Plane.
  - In the Origin folder of Frame:1, select the XY Plane.
  - Click **Apply**.

- 3 Repeat to create flush constraints between XZ/XZ planes and YZ/YZ planes.

## iCopy Author - Layout tab

The iCopy Author prepares an assembly for the iCopy command. To use an assembly as an iCopy template, the assembly must contain a skeleton part that drives the other parts in the assembly. The skeleton part must contain an adaptive sketch. You select points in the sketch to use as the control points for placing the iCopy. The parameters in the skeleton part can be added to the iCopy template. These parameters give greater control over the size and shape of the assembly and its components.

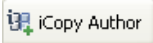
- 1 Start the **iCopy Author** command. 
  - In the Ribbon: Manage tab ► Author panel ► **iCopy Author**
  - In the classic interface: Assembly panel ► iCopy Author
- 2 In the browser, select Skeleton-frame:1. After the layout part is selected, the Geometry and Parameter tabs become available.

## iCopy Author - Geometry tab

On the Geometry tab, select and name the control points in the layout part. The control points are used to position the iCopy result when it is placed in an assembly. These points must be geometry points (end points of lines, center points of circles, but not sketch points).

- 1 Select the **Geometry** tab.
- 2 In the Point column, click **Click to add**.
- 3 Select the point in the lower left corner of the frame.

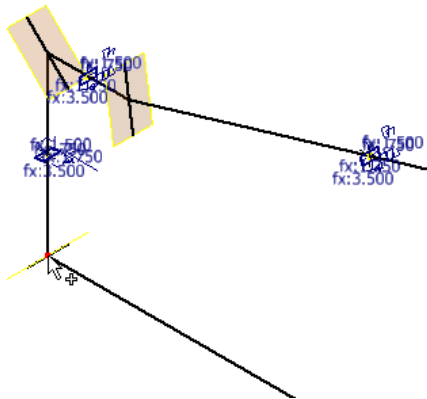

- 4 In the Label field, enter **Lower left**.
- 5 In the Point column, click **Click to add**.
- 6 Select the point in the lower right corner of the frame.

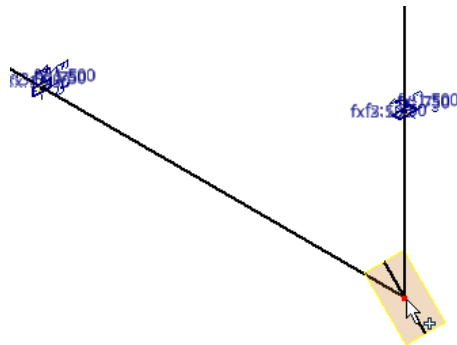

- 7 In the Label field, enter **Lower right**.
- 8 In the Point column, click **Click to add**.
- 9 Select the point at left end of the upper middle frame member.

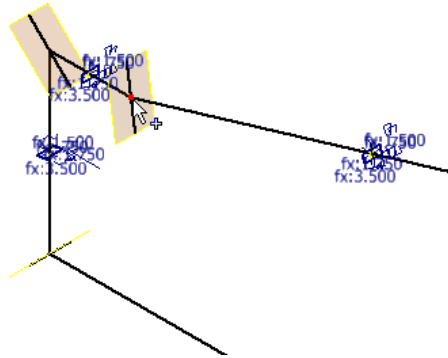

- 10 In the Label field, enter **Upper left**.
- 11 In the Point column, click **Click to add**.
- 12 Select the point at the right end of the upper middle frame member.

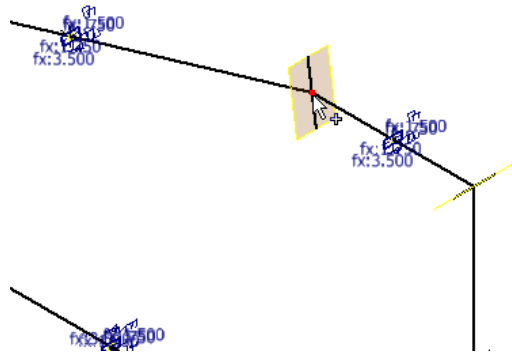

- 13 In the Label field, enter **Upper right**. Click a blank area of the dialog box to accept the input.

---

**NOTE** To remove a work point from the list, highlight the Point and Label fields then press <Delete>.

---

## iCopy Author - Parameter tab

On the Parameter tab, include parameters from the layout part in the iCopy template. You can modify the parameter values when placing the iCopy in the target assembly.



- 1 Select the **Parameter** tab. There are two parameters in the list on the right. These parameters are user parameters defined in Skeleton-frame.
- 2 Select the Label field for FrameH and enter **Frame Height**.
- 3 Select the Label field for FrameW and enter **Frame Width**. Click a blank area of the dialog box to accept the value.
- 4 Click **OK**.
- 5 Save the file. Click **Yes to all** if prompted.
- 6 Close Frame.iam.

## Test the iCopy Definition

When creating an iCopy definition, test the iCopy with just the skeleton. Test again after you create all the derived parts. Then finally test after placing any other components. You test the iCopy definition by using it with the iCopy command to verify it updates as expected.

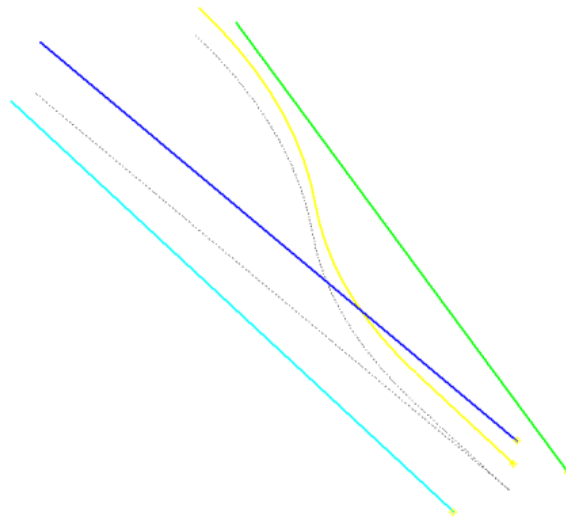
- 1 Open Target.iam.



- 2 Start the **iCopy** command. 
  - In the Ribbon: Assemble tab ► Component panel ► **iCopy**
  - In the classic interface: Assembly panel ► iCopy
- 3 Click  and select **Frame.iam**. Click **Open**. The Constrain iCopy dialog box displays.
- 4 Select the work point at the end of the cyan (light blue) line for the Lower left point.

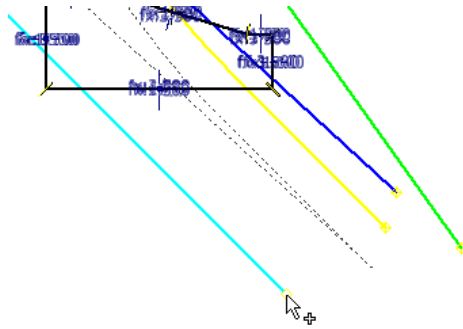

- 5 Select the work point at the end of the green line for the Lower right point.

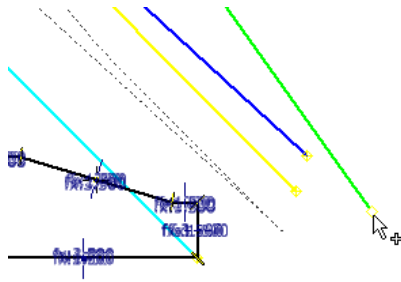

- 6 Select the work point at the end of the blue line for the Upper left point.

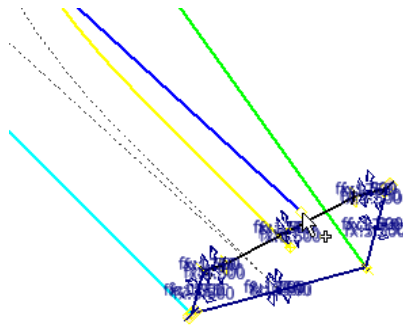

- 7 Select the work point at the end of the yellow spline for the Upper right point.

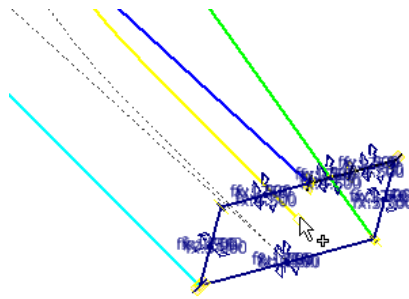

- 8 Click  in the lower right of the dialog box to display the multiple results settings.
- 9 Select the cyan (light blue) line to use as the path for the pattern (the Path button is selected automatically). The Work Plane is selected automatically based on the selected path.

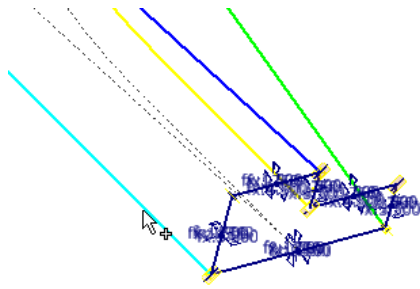

- 10 The values for Instance number and Occurrence persist from the last time you used iCopy.

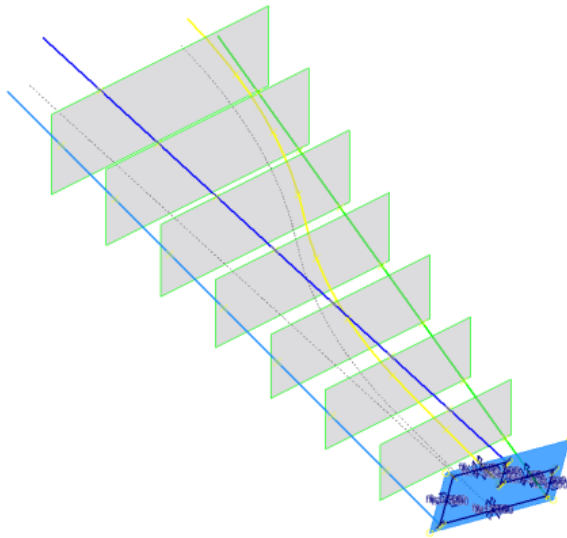

- 11 Click **OK** to complete the command. The Copy / Reuse iCopy Components dialog box does not display because there are no components to reuse in the iCopy definition.
- 12 The iCopy results are created as shown. If the iCopy is not successful, return to the iCopy template and review the steps to create it.

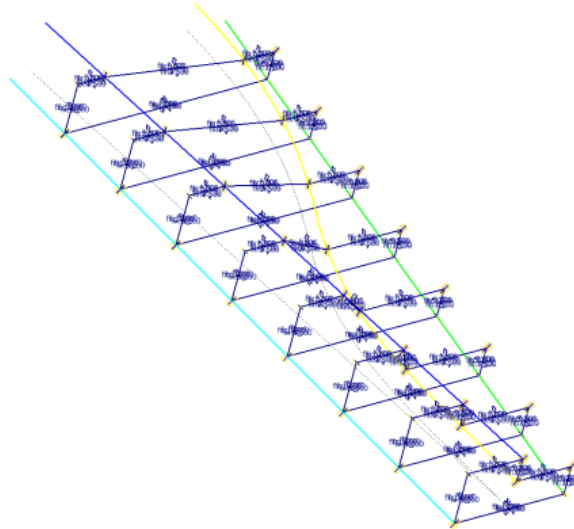







- 13 Click **Undo** to remove the iCopy results from the target assembly. This assembly is used for further testing.
- 14 Close the file. Do not save changes.

## Create a Frame Part

Now that the skeleton assembly has been successfully tested, you continue building the assembly. Next, create a frame part by deriving geometry from the Skeleton-frame part.

- 1 Open Frame.iam.
- 2 Click **Create** to create a component within the assembly.
  - Enter **Frame1** in the New Component Name field.
  - Click  and select Standard (in).ipt from the English folder.
  - Verify that the New File Location is set to the folder where you extracted the tutorial files.
  - Verify that **Constrain sketch plane to selected face or plane** is not selected.

- Click **OK**.
- 3 In the browser, expand the Origin folder and select the XY Plane.
- 4 Exit the sketch and delete Sketch1. It is not needed for this component.
- 5 Start the Derive command.
- 6 In the Open dialog box, select Skeleton-frame.ipt and click **Open**.
- 7 Expand the Surface Bodies node. Set Srf1 and Srf6 to  and all other surfaces to .
- 8 Expand the Sketches node. Set Sketch2 to  and all other sketches to .
- 9 Expand the Work Geometry node. Set Work Plane5 to  and all other work planes to .
- 10 In the Derive dialog box, click **OK**. The surfaces and sketch from Skeleton-frame are added to the part. Using Derive to add these surfaces maintains a link between the two files. The visibility of Skeleton-frame.ipt is turned off for clarity in the following image.



- 11 Start the Extrude command.
  - Sketch2 is selected automatically. It is the only closed profile in the part.
  - In the Extents drop-down, select **From To**.
  - Select **Srf1** and **Srf6** as the From To planes. The order does not matter.
  - Click **OK**.

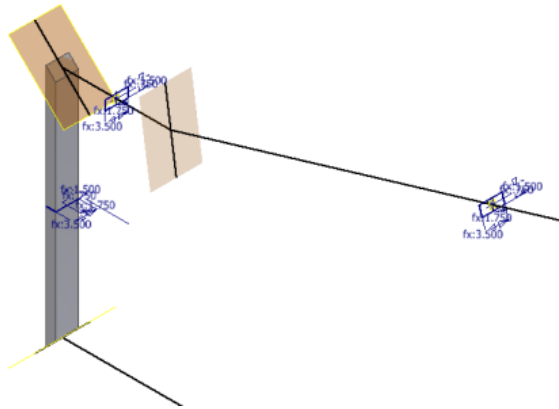

- 12 For clarity, turn off the visibility of the objects under the derived component.
- 13 Return to the main assembly (Frame.iam).

## Complete the Assembly

Repeat the previous procedure to create the rest of the assembly. The table contains a list of file names with the surfaces, sketches, and work planes to use with the Derive command.

- 1 Repeat the procedure to create the five frame parts according to the following table:

File Name	Surfaces	Sketch	Work Geometry
Frame2	Srf1 and Srf2	Sketch3	Work Plane6
Frame3	Srf2 and Srf3	Sketch4	Work Plane1

File Name	Surfaces	Sketch	Work Geometry
Frame4	Srf3 and Srf4	Sketch5	Work Plane2
Frame5	Srf4 and Srf5	Sketch6	Work Plane3
Frame6	Srf5 and Srf6	Sketch7	Work Plane4

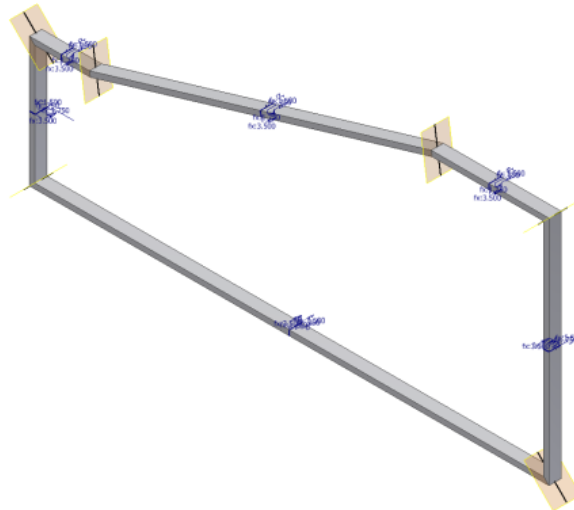

- 2 When all part files are complete, save Frame.iam and all dependents.

## Constrain the Frame Part

For adaptivity and skeleton modeling to work together, the assembly must be constrained using a particular workflow. Constrain the origin planes of the components to the origin planes of the iCopy template layout part. This procedure provides the most consistent results.

- 1 In the model window, click and drag any frame part. The part is not constrained and is free to move.
- 2 In the browser, expand the Origin folders for Frame1:1 and Skeleton-frame:1.

- 3 Start the Constrain command. In the Solution area of the dialog box,
  - Select the Flush option.
  - In the Origin folder of Skeleton-frame:1, select the XY Plane.
  - In the Origin folder of Frame:1, select the XY Plane.
  - Click **Apply**.
- 4 Repeat to create constraints between XZ/XZ planes and YZ/YZ planes.
- 5 Repeat the process for the three origin planes of the remaining frames (Frame2 through Frame6).

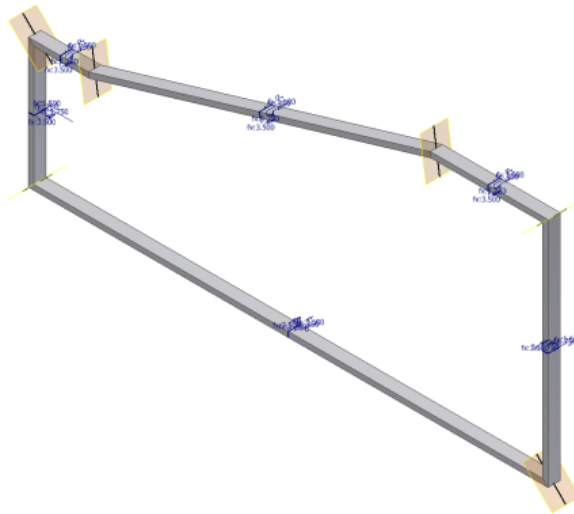



- 6 Save and close the file.

## Test the iCopy Definition

Test the iCopy definition again. The frames are the only parts that are derived from the skeleton part. There are other components that are independent of the skeleton part. These components are placed later.

- 1 Open Target.iam.

- 2 Start the **iCopy** command. 
- In the Ribbon: Assemble tab ► Component panel ► **iCopy**
  - In the classic interface: Assembly panel ► iCopy

- 3 Click  and select **Frame.iam**. Click **Open**. The Constrain iCopy dialog box displays.
- 4 Select the work point at the end of the cyan (light blue) line for the Lower left point.

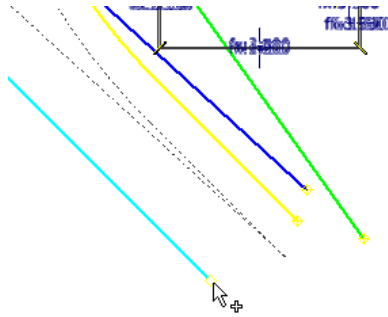

- 5 Select the work point at the end of the green line for the Lower right point.

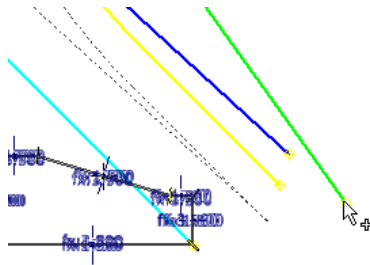

6 Select the work point at the end of the blue line for the Upper left point.

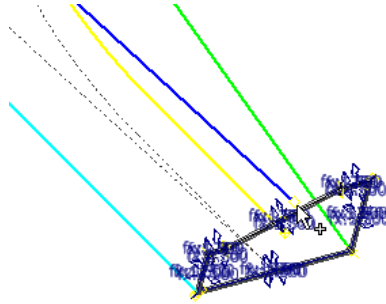

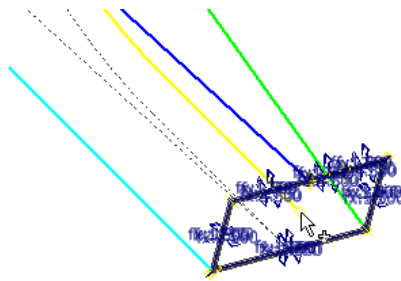

7 Select the work point at the end of the yellow spline for the Upper right point.

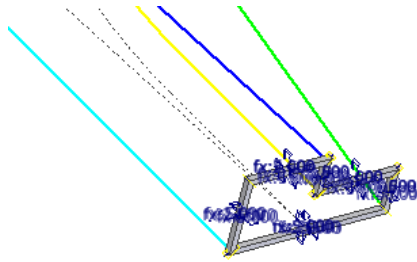

8 In the Frame Height field, enter **5 in.**

9 In the Frame Width field, enter **5 in.**



- 10 In the lower right of the dialog box, click  to display the multiple results settings.
- 11 Select the cyan (light blue) line to use as the path for the pattern (the Path button is selected automatically).

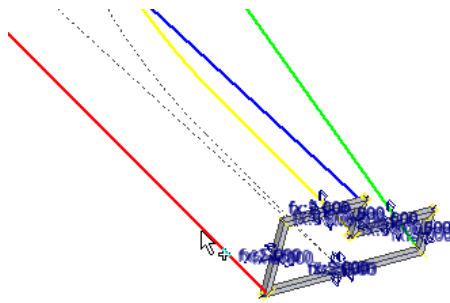

- 12 The Work Plane is selected automatically based on the selected path.

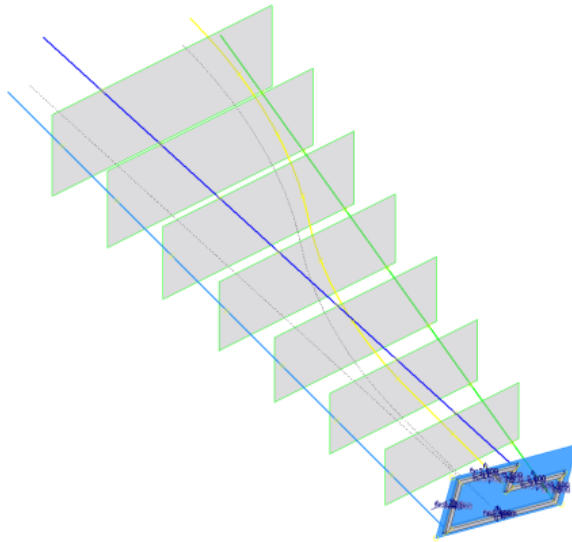

- 13** The values for Instance number and Occurrence persist from the last time you used iCopy.
- 14** Click **OK** to complete the command. The Copy / Reuse iCopy Components dialog box does not display because there are no components to reuse in the iCopy definition.
- 15** The iCopy results are created as shown. If the iCopy is not successful, return to the iCopy template and review the steps to create it.

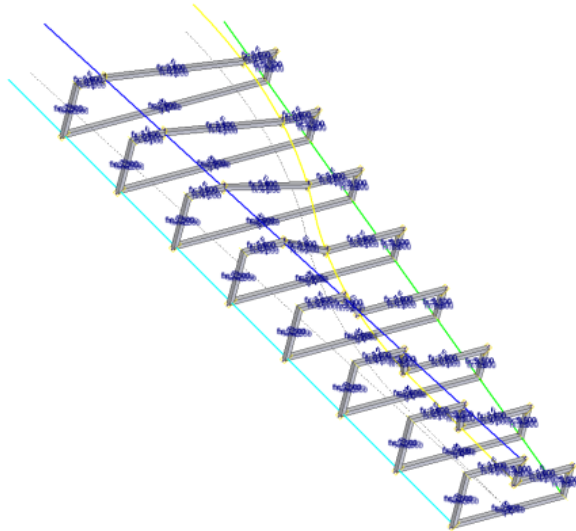

- 16 Click **Undo** to remove the iCopy results from the target assembly. This assembly is used for further testing.
- 17 Close the file. Do not save changes.

## Place the Support Plates

The last step in building the iCopy template is to place any components that are independent of the skeleton layout part. Support plates are placed and constrained in the assembly.

- 1 Open Frame.iam.
- 2 Place four occurrences of Plate1.ipt.
- 3 Use one mate and two flush constraints to position each plate at the four lower corners of the frame as shown. Use the vertical frame parts with the mate constraint to position the plates. This procedure provides more consistent results because the horizontal frame changes when placing iCopy results.

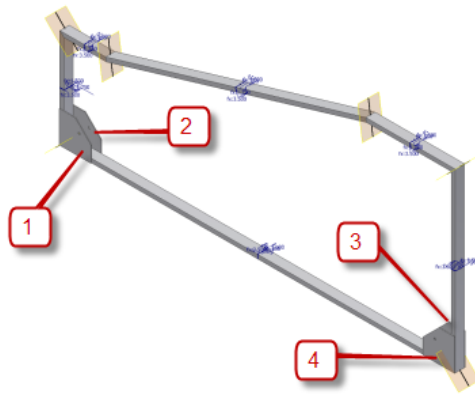

4 Turn off the visibility of Skeleton-frame:1.

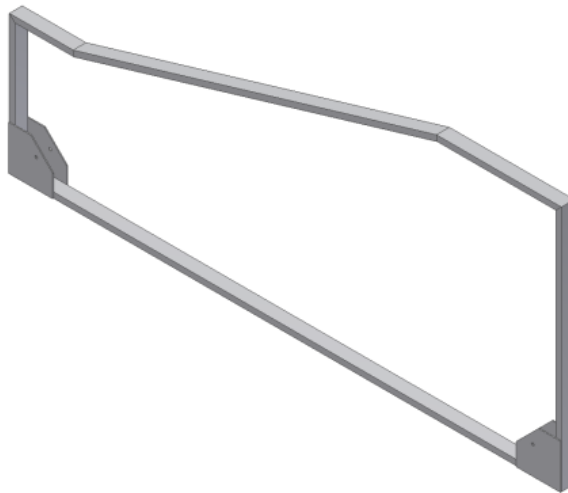



5 Save Frame.iam and all its dependents. Close the file.

## Test the iCopy Definition

Now that all the parts are placed in the iCopy template, test a final time to verify that everything works as expected.

1 Open Target.iam.

- 2 Start the **iCopy** command. 
- In the Ribbon: Assemble tab ► Component panel ► **iCopy**
  - In the classic interface: Assembly panel ► iCopy

- 3 Click  and select **Frame.iam**. Click **Open**. The Constrain iCopy dialog box displays.
- 4 Select the work point at the end of the cyan (light blue) line for the Lower left point.

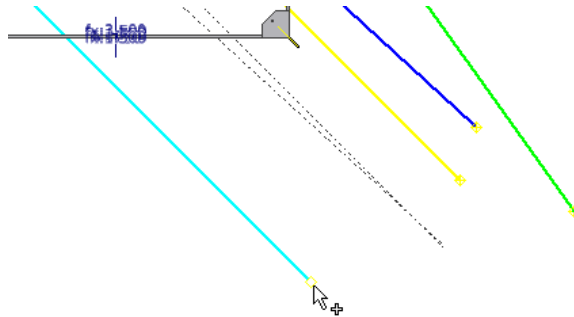

- 5 Select the work point at the end of the green line for the Lower right point.

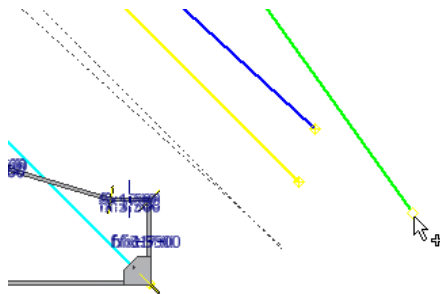

- 6 Select the work point at the end of the blue line for the Upper left point.

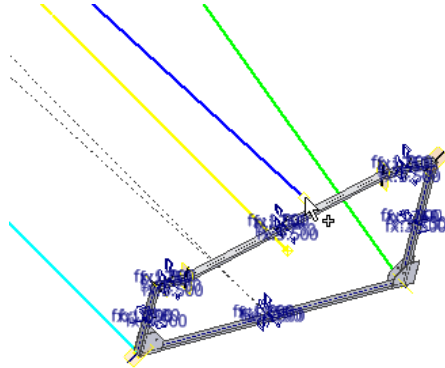

- 7 Select the work point at the end of the yellow spline for the Upper right point.

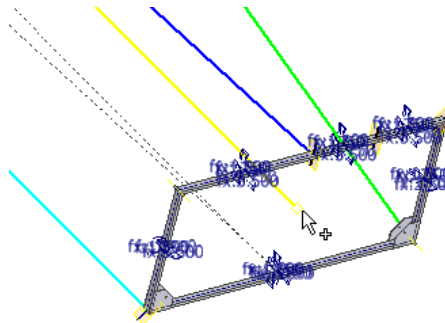

- 8 In the Frame Height field, enter **5 in.**
- 9 In the Frame Width field, and enter **5 in.**
- 10 In the lower right of the dialog box, click  to display the multiple results settings.
- 11 Select the cyan (light blue) line to use as the path for the pattern (the Path button is selected automatically).

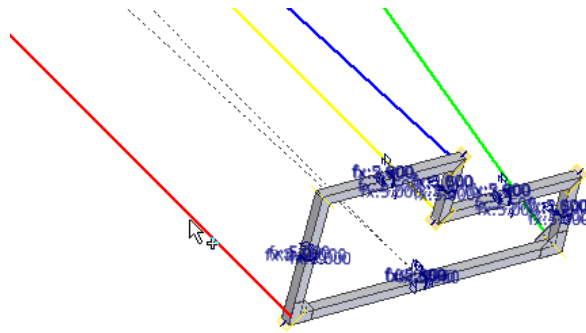

- 12 The Work Plane is selected automatically based on the selected path.
- 13 The values for Instance number and Occurrence persist from the last time you used iCopy.

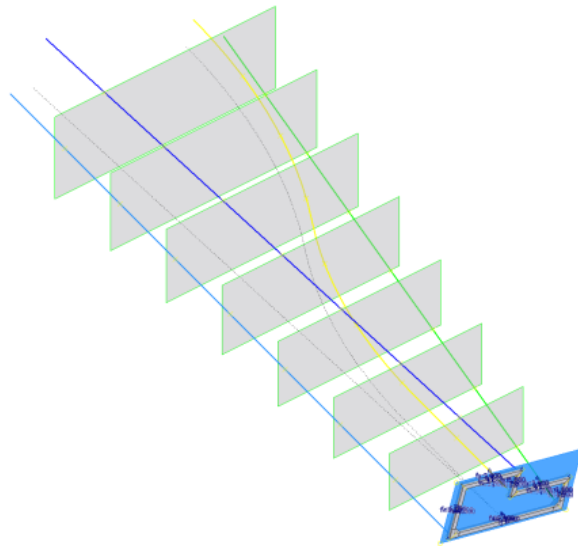

- 14 Click **Next** to continue the command. The Copy / Reuse iCopy Components dialog box displays because there are components that can be reused in the iCopy definition.
- 15 Click **OK** to accept the defaults. The frame parts are copied for each iCopy result. Each iCopy result uses the plate part.

- 16** The iCopy results are created as shown. If the iCopy is not successful, return to the iCopy template and review the steps to create it.

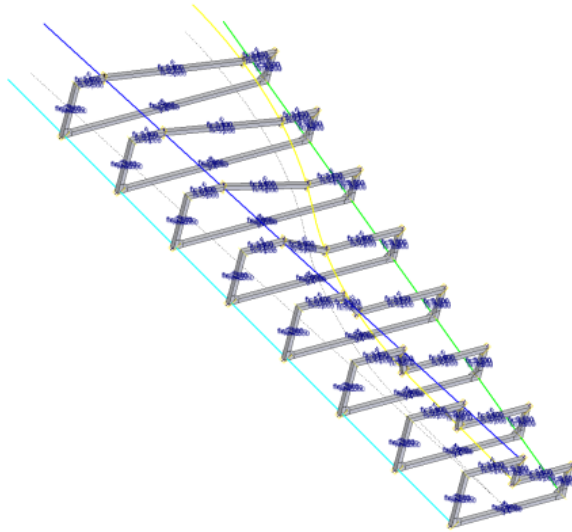

- 17** Save Target.iam and its dependents.

## Summary

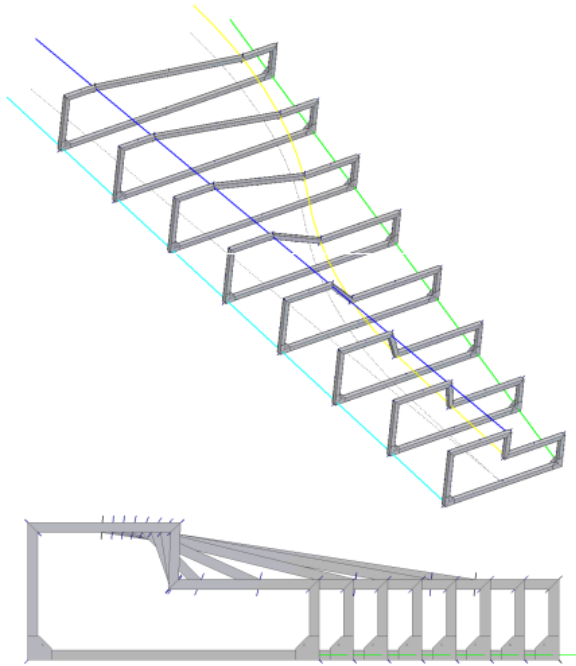

Congratulations! You have completed this tutorial. In this exercise, you:

- Authored an iCopy template
- Created iCopy results in a target assembly

**What Next?** Now that you know how to author and place iCopy components, you can create your own. The Skeletal Modeling tutorial helps you understand how to set up a skeleton assembly to use with iCopy.

# Index

